

NORDIC TRANSDUCER

Long Distance MS902 Series Draw Wire Position Sensor

Series MS902 **20 meter**

1. Output types

- Analogue: potentiometer,0-10V,0-5V,4-20mA
- Digital: TTL/push-pull/OC
- Digital-Absolute: SSI



2. Linearity

- Analogue output $\pm 0.12\%$ of FS
- Digital/Digital-absolute $\pm 0.05\%$ of FS

3. Technical data

Output type	Digital	Analogue
Measure Range	0-20m	0-20m
Sensor element	Encoder	Potentiometer
Stainless steel	Ø1.3mm High tenacity wire-rope	Ø1.3mm High tenacity wire-rope
Output	Open Collect (PNP)	0-5KΩ, 0-10KΩ
	Long Line Driver	4-20mA, 2wire or 4 wire
	Push pull	0-5V,0-10V
Translation circuit	No	Built-in, External, External module
Output zero and output full	No	Adjustable
Linearity	$\pm 0.05\%$ FS	$\pm 0.12\%$ FS
Repeatability	0.01%	0.01%
Resolution(mm)	0.25,0.16,0.05,0.04, etc.	Infinitesimal
Max. Velocity	4000mm/S	4000mm/S
Start Force	6N	6N
Vibration frequency	50HZ	50HZ
Response frequency	300K Hz	300K Hz
Power	Due to output	<1W
Working voltage	5V 5-24V	10-30V,12V, 24V, 28V
Weight	9.2kg	9.2kg
Working temp range	-10C~+85C	-10C~+85C

Service life	>200Mio	>200Mio
Anti- vibration	10HZ-1500HZ; 10G	10HZ-1500HZ; 10G
Cable length	4M	4M
Housing component	Titanium-anodized Aluminum, the coating is a hart anodic oxidation that protects the sensor from corrosion	Titanium-anodized Aluminum, the coating is a hart anodic oxidation that protects the sensor from corrosion
Protection Class	IP65	IP65

MS901-MS906 Size Diagram

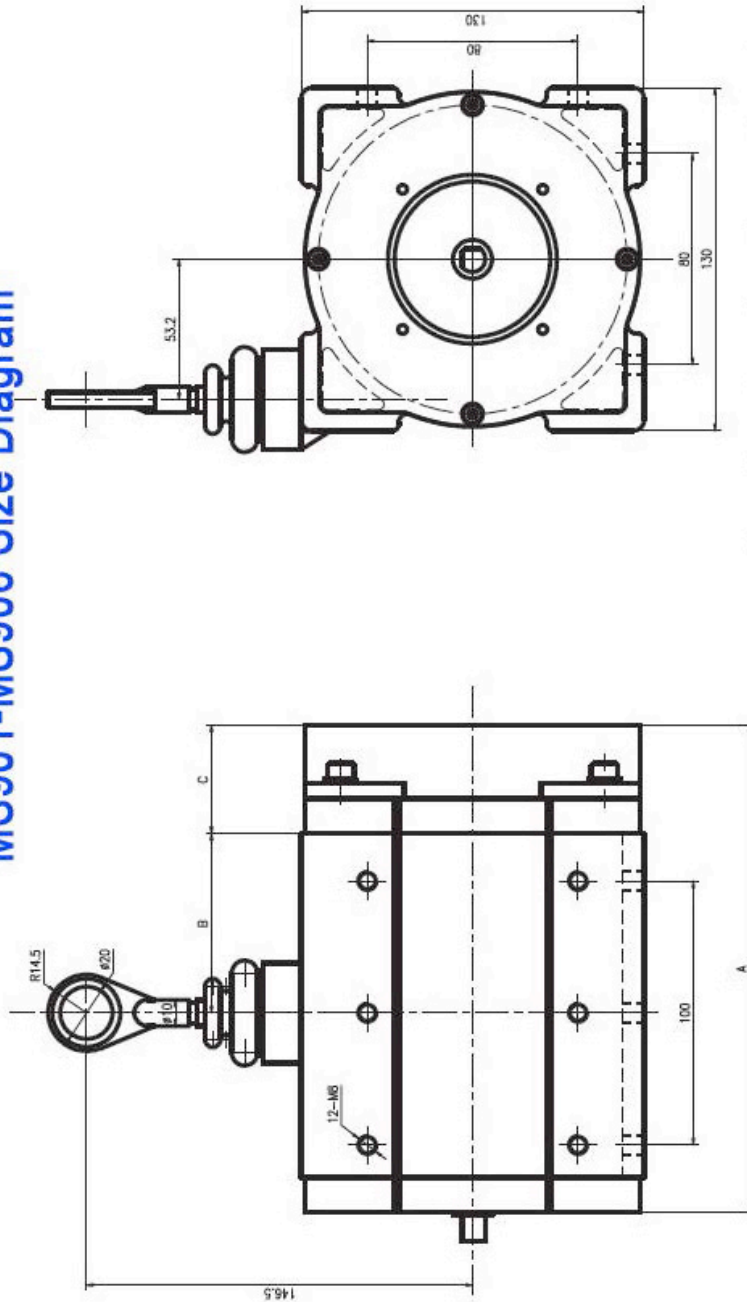

	A	B	C	A	B	C	
MS901	184.5	68	41	MS904	482.5	158	159
MS902	365.5	113	132	MS905	482.5	158	159
MS903	482.5	158	159	MS906	482.5	158	159